



TMdrive[®]-MVe2 Product Application Guide

Medium Voltage Multilevel IGBT Drive
Up to 5,500 HP (5,000 kVA), 3.3 kV to 11 kV

metals

cranes

mining

testing

oil & gas

renewable
energy

power
generation

cement

The TMdrive®-MVe2 is an enhancement to the family of TMEIC medium voltage general purpose drives offering:

- Regeneration
- Smaller footprint
- Unity line-side power factor
- Reduced part-count
- High availability



Design Feature	Customer Benefit
Active line side converter	<ul style="list-style-type: none"> • Unity (1.0) power factor across entire speed range • Line side harmonics much lower than IEEE 519-2014 • Standard regenerative braking
Conservative electronic design & dry film-type capacitors	<ul style="list-style-type: none"> • Highly reliable operation, expected 16-year MTBF • No need for periodic capacitor replacement
Multilevel drive output voltage waveform	<ul style="list-style-type: none"> • No derating of motor for voltage insulation or heating required • Applies easily to existing motors without the need for an expensive output filter • Eliminates the need for special VFD rated cables • No Neutral Shift
Input isolation transformer with static shield included in drive package	<ul style="list-style-type: none"> • Simplifies design and installation • Less total space required, plus easy integration in MCC building • Better motor protection than transformerless design • High frequency transients are attenuated
Power conversion module in a single drawer type package	<ul style="list-style-type: none"> • Reduction in spare parts • Minimal personnel training for maintenance • 30 minutes Mean Time to Repair (MTTR)
Synchronous bumpless transfer of the motor to the utility line	<ul style="list-style-type: none"> • Allows control of multiple motors with one drive • No motor current or torque transients when the motor transitions to the AC line

Covering a broad range of medium voltage drive applications

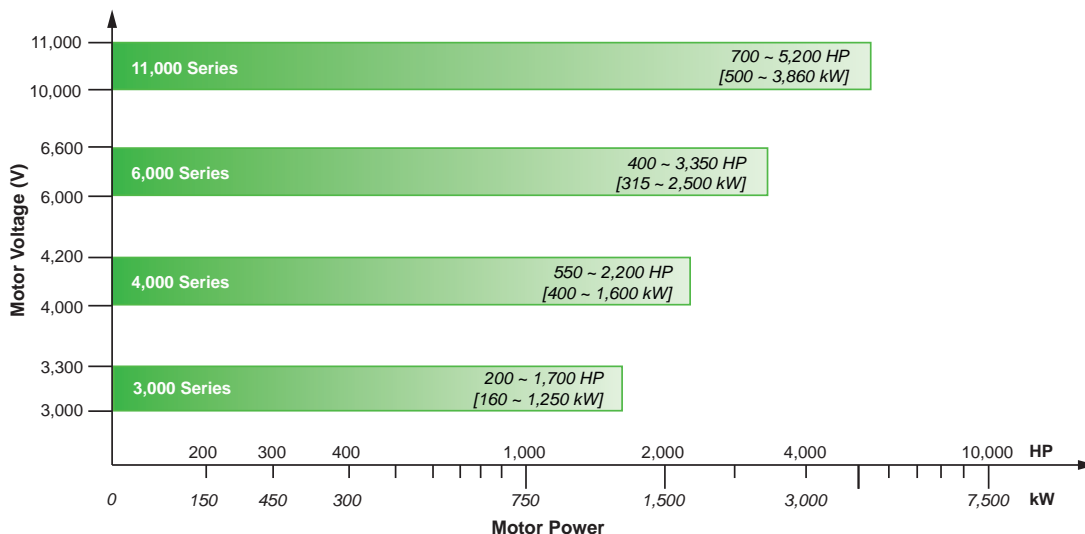

Designed for the most demanding applications

Oil & Gas

For Oil and Gas applications, the MVe2 family of variable frequency drives seamlessly integrates with the rest balance of process with a choice of 3/3.3 kV, 4.16 kV, 6/6.6 kV, 10kV or 11 kV options. The MVe2 can be applied to existing motors and cabling, making them an excellent option in modernization/retrofit applications, including:

- Oil pumps
- Expanders
- Gas compressors
- Extruders
- Fans
- Mixers



Power Generation

Traditional mechanical methods of controlling flow are inefficient and require considerable maintenance. In the Power Generation/Utilities industry, the MVe2 provides more reliable, accurate and energy-efficient control of flow while eliminating the maintenance associated with dampers, vanes or valves for:

- Induced and forced draft fans
- Primary and secondary air fans
- Boiler feed water pumps
- Condensate extraction pumps

Mining

Accurate torque control is a key in controlling large conveyors. The MVe2's flux vector algorithm provides the accuracy and response for constant torque applications. Mining applications include:

- Raw material conveyor
- Grinding mills
- Pumps
- Crushers
- Shredders
- Hoists



Industrial

Regardless of the torque profile, MVe2 drives are designed to meet motor control needs in a variety of industries:

- Steel
- Water & wastewater treatment
- Rubber & plastics
- Test stands
- Agriculture
- Paper & pulp
- Recreational/Entertainment

A Look Inside

Differentiating Features

- Compact design saves valuable floor space making retrofits of old equipment easier
- Compartmentalized panels provide voltage class segregation and top or bottom cable feeds
- Integral isolation transformer provides reliable operation and simplifies installation.
- Significant reduction in parts, reducing spare parts requirements

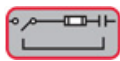

Input Power Disconnect Option†

- A visible, bolted pressure, isolation switch offers mechanical interlocking to allow for maintenance personnel to service the drive.
- The fused (Class E rated) vacuum contactor provides critical fault current protection to the drive.

Main Power Input

Four voltage levels are available:

- 3-3.3 kV, 3-phase, 50/60 Hz
- 4-4.16 kV, 3-phase, 50/60 Hz
- 6-6.6 kV, 3-phase, 50/60 Hz
- 10-11 kV, 3-phase, 50/60 Hz



Internal Pre-Charge AC Reactor*

An ac reactor and medium voltage contactor mitigate the transformer magnetizing inrush current, minimizing stress on the fusing and power components.

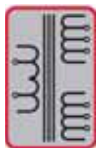

Input Isolation Transformer Standard.

The input transformer has multiple secondary windings to feed IGBT inverters (cell inverters). This design provides galvanic isolation between the power system and the motor-inverter system. Electrostatic shield is standard.

Kirk Key Interlocks†

For additional safety, Kirk key locks are provided standard on all drives.



Filtered Air Intake

Washable input air filters have front access for periodic maintenance.

* Available in select frame sizes

† For 4 kV drive, CSA listed in U.S. and Canada only.

...Beautifully Packaged.



Blower Assemblies

Quiet (<80 dB(A) at 1m), fans circulate air throughout enclosures pulling air from the front filter assemblies and venting it out the top of the cabinets. Redundant fan assemblies can be provided as an option.



Control

Single 32-bit microprocessor-based control board combines several key drive functions:

- Power semiconductor gating
- Speed and torque regulation
- Motor and drive protection
- I/O mapping
- Diagnostic functions
- High speed data capture buffering
- Hosting of optional LAN interface
- Drive is configured from the TDrive-Navigator

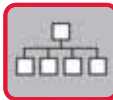

Communications

An optional communications card can be provided to connect the VFD to the DCS/SCADA system.



Application Specific Controls

Each drive is matched to project requirements with custom control components.



Remote Connectivity Module Standard.

On-board Windows® based computer provides access to live variables, parameters & historical fault data.



Power & Motor Cabling Terminations

Conveniently located power cable terminations can be accessed from the front or rear. A metal cover prevents exposure to live parts when drive is running.



Lightning Arrestors†

Incoming power is protected by distribution class lightning arrestors for suppression of transient surges.

Control & Power Cables

Gland plates are provided to enable cable entry. Top and bottom entry options are selectable onsite.

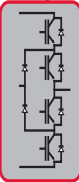

Inverter/Converter Phase-Leg Assemblies

Each modular phase leg assembly includes:

- Robust IGBTs
- Gate driver circuit board
- DC bus capacitors, dry-film type for long life
- Fiber optic link interface circuit board

A phase leg assembly can be easily racked out and replaced in 30 minutes in case of failure.

Utility & Motor

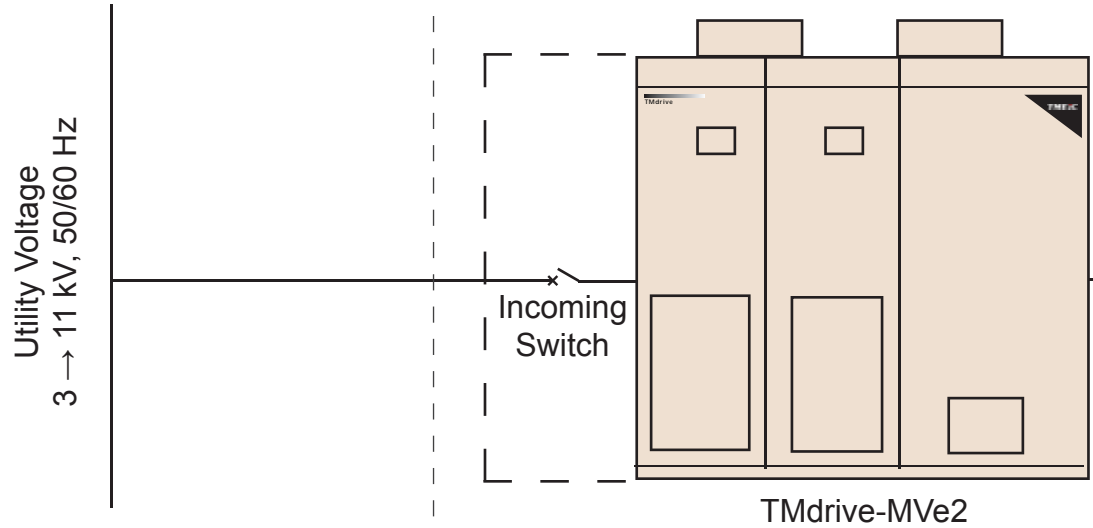

High Input Power Factor. Reduced Electricity Charges.

The PWM converter maintains a unity power factor across the entire speed range eliminating the need for correction equipment and utility penalties.

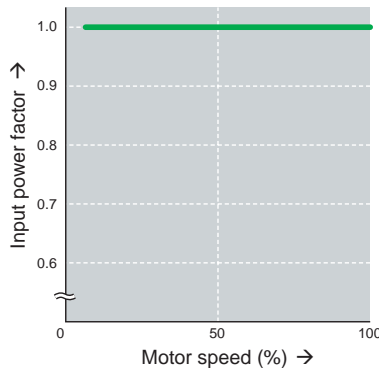

Example of the actual load test result of the standard 4-pole motor

High Efficiency. Reduced HVAC Costs.

The MVe2 has a full load efficiency of 96.5%, including auxiliaries and isolation transformer. As an option the input isolation transformer can be mounted outdoors, reducing the heat load by 50%.

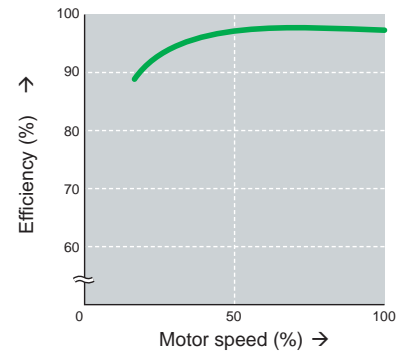

* Example of the actual load test result of the standard 4-pole motor

Extremely Low Harmonics. No line-side filter required.

The MVe2 line side harmonics are much lower than IEEE 519-2014 requirements. Less than 2% current distortion is seen by utility.

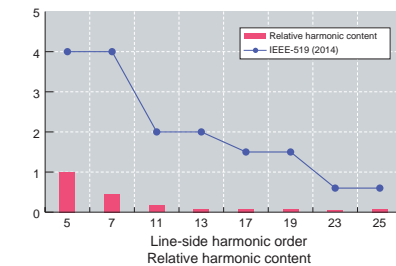
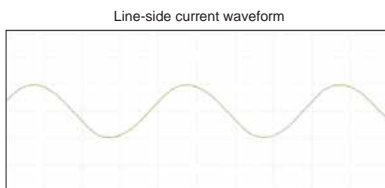

Utility Interruption Protection.

Momentary power loss & voltage unbalances can cause harmful effects to a motor. The MVe2 VFD control remains active during instantaneous power loss for up to 2 seconds. For power outages longer than 2 seconds, the VFD can regain motor control of a spinning load.

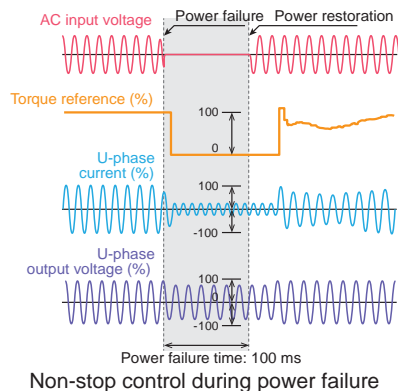

Utility Energy Return

The power regeneration function enables stopping of large inertia loads in a short time. During deceleration the rotational energy is returned to the power supply. This reduces energy consumption and electricity costs versus conventional models that can only provide for a coasting stop.

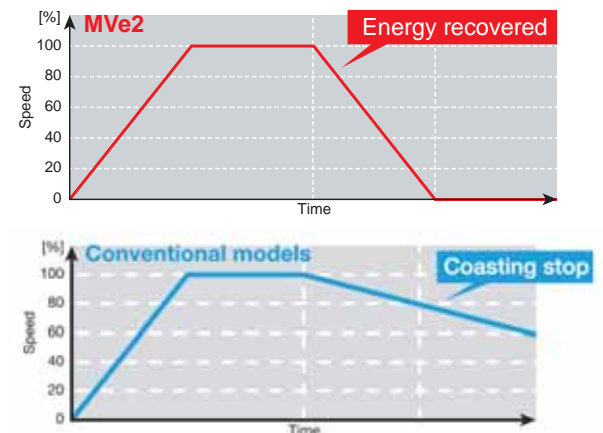

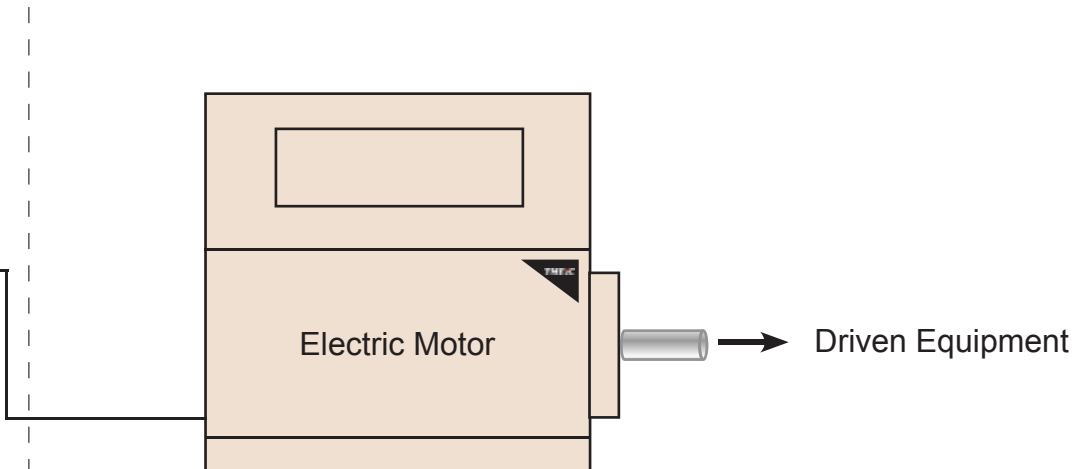

Engineered Motor-Drive Packages. Single point of contact.

Through TMEIC's extensive application expertise, we deliver motor-drive solutions that support your technical and commercial needs from concept to decommissioning.

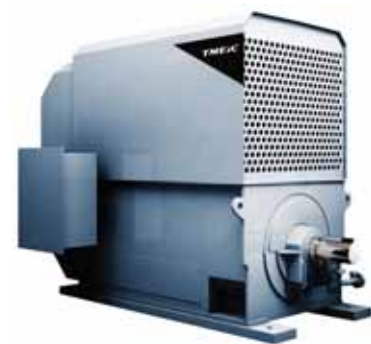

Apply to Existing Motors

The multilevel PWM output waveform approximates a sine wave, reducing dv/dt. Less than 2% I_{THD} and V_{THD} .

- 3-4.16kV: 9 levels (0 to peak) / 17 levels (peak to peak)
- 6-6.6 kV: 13 levels (0 to peak) / 25 levels (peak to peak)
- 10-11 kV: 21 levels (0 to peak) / 41 levels (peak to peak)

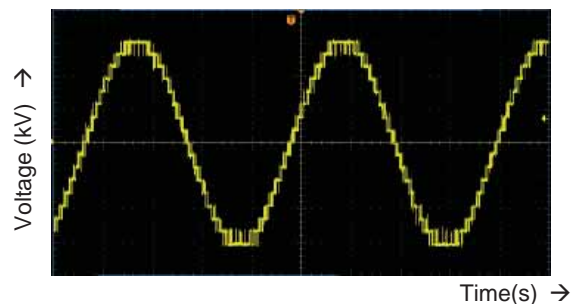

*Example of the actual test result of the standard 4.16 kV VFD

Rapid Acceleration / Deceleration

The standard regenerative braking function provides for rapid acceleration and deceleration with quick speed response.

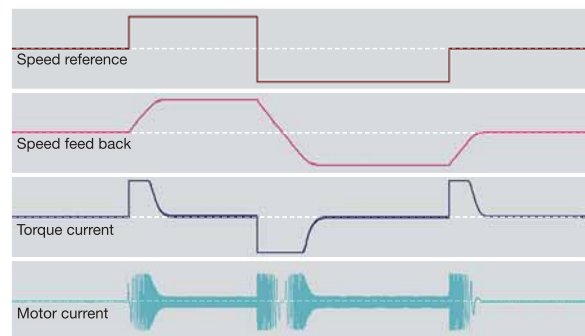

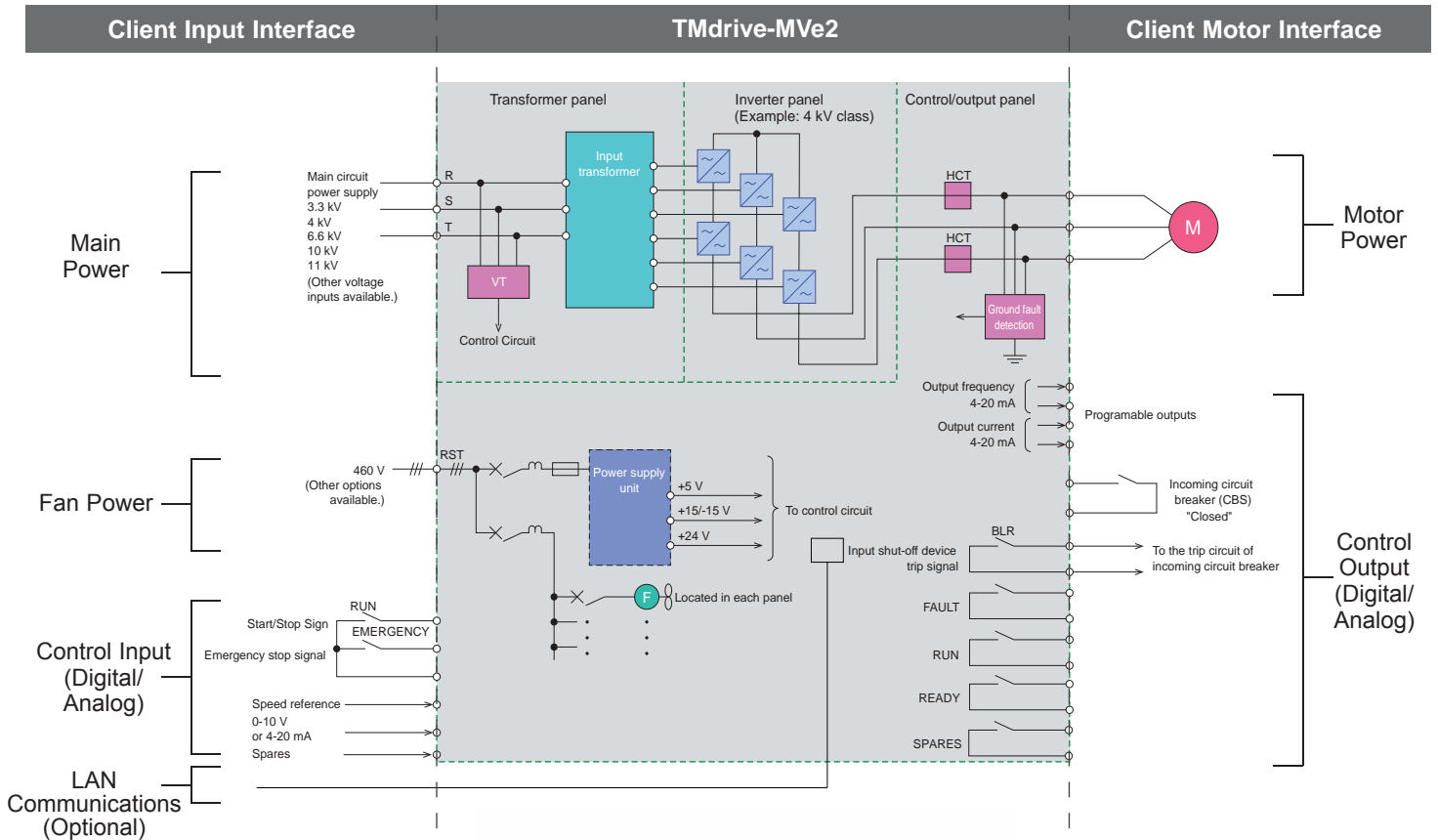

Control I/O terminals



Door-mounted HMI



Low voltage fan input terminals



Incoming power terminals



Motor lead terminals

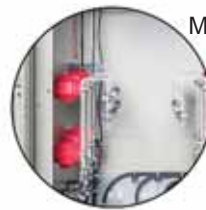



An optional lifter cart enables the operator to quickly rack-in/out the power modules.



Drawer type cell inverters shorten MTTR to 30 minutes



A convenient isolation switch kills the main power to the VFD to allow for safe servicing.



Aluminum mesh air filters can be removed and cleaned while the VFD is running.

System configurations

...flexible and scalable.

The MVe2 can be applied to your process in flexible configurations.

<p>Running duty</p>		<p>When appropriately rated, the MVe2 can be applied for continuous duty applications providing:</p> <ul style="list-style-type: none"> • Speed/process control • Unity line side pf • Quick deceleration • Constant/variable torque • Reduction in in-rush current
<p>Running and/or starting duty</p>		<p>TMEIC provides integrated packing of:</p> <ul style="list-style-type: none"> • Industrial Control Building • Output/Bypass Switchgear • Motor Control Centers • Control Systems <p>The MVe2 can be rated either for starting duty and/or running duty. With the appropriate switchgear lineup, the MVe2 control can automatically accelerate the connected motor to match the incoming utility voltage, frequency and phase. The load can then be bumplessly transferred to power source with no surges in torque or current. This allows for sequential starting of multiple motors with a single VFD. In a redundant arrangement, any motor can be started with either VFD, or can be configured as a hot-standby. Alternatively, the VFD can also capture the motor from the utility line and regain speed control.</p>

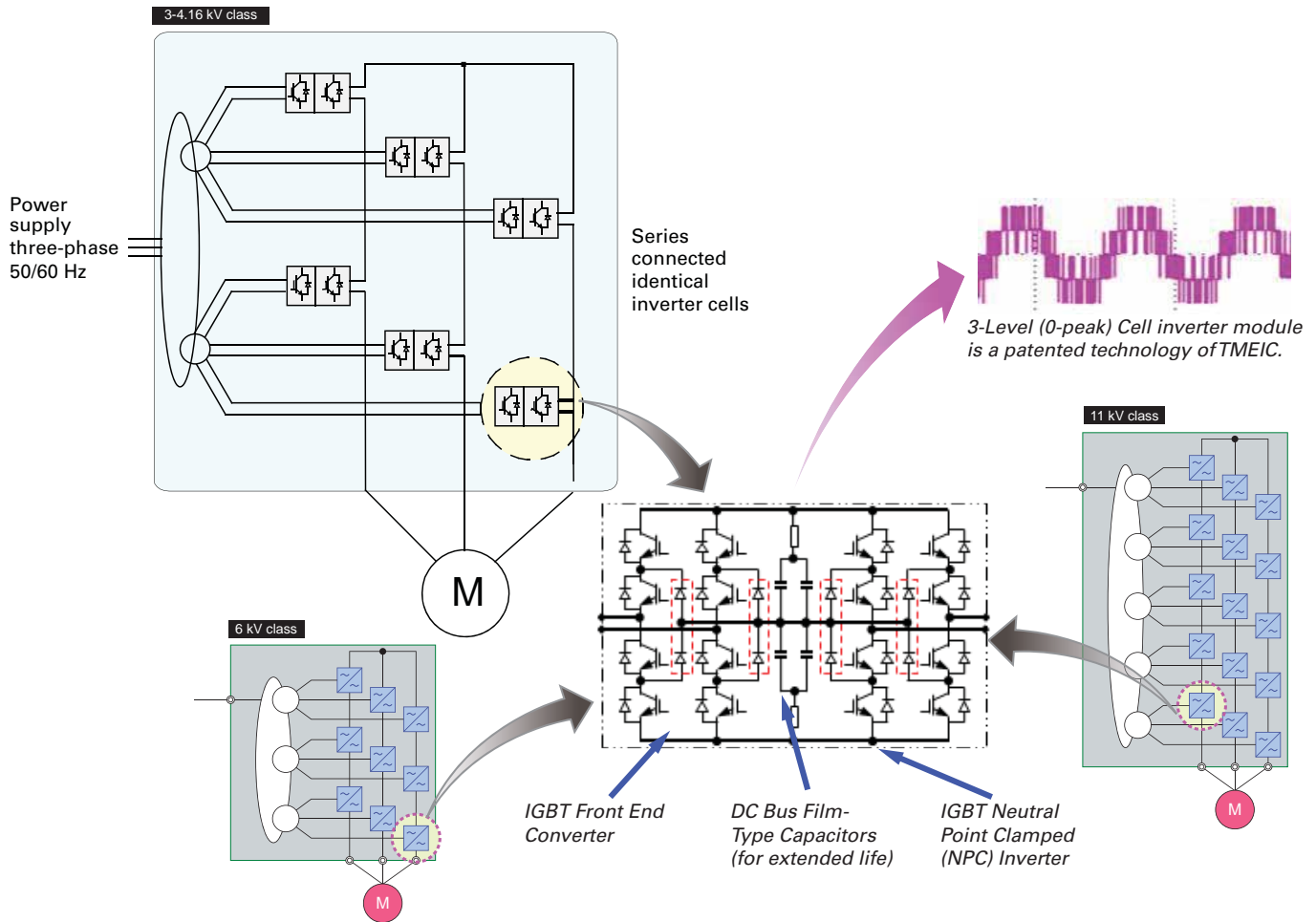

Rack In-Rack Out

...in 30 minutes.

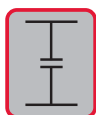

DC Link Long Life Capacitors
Dry film type capacitors eliminate need for replacement (no electrolytic capacitors)



Switching Devices
Switching devices are insulated gate bipolar transistors (IGBT)



Easy Rack-Out
Convenient handles enable easy removal of power modules

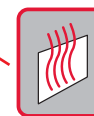

Cooling Heat Sink
Heat is transferred from the switching device to the heat sink

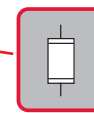

Input Fuse
Fused inputs to converter

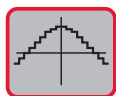

Control Board

- Board passes pulse width modulated control signal to gate drivers
- Gate driver circuit boards connect directly to IGBTs

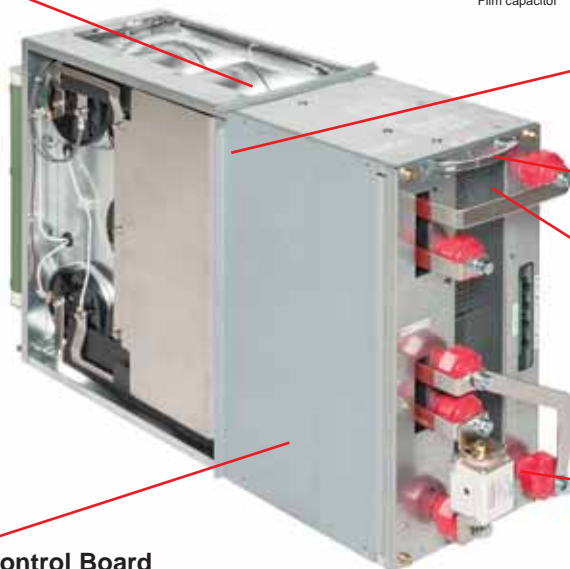

Frame Sizes to Fit Your Application

4-4.16 kV[†]

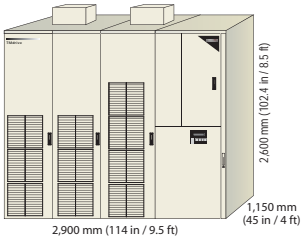
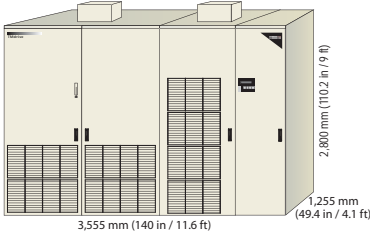
VFD Outline	Maximum Weight lbs. (kg)	Approximate Motor Shaft HP (kW) at 4.16 kV	Rated Output Current (A) I phase AC*	Inverter kVA output at 4.16 kV	
	Frame 100	9,300 (4,218)	536 (400)	69	500
	Frame 200	9,300 (4,218)	1,085 (810)	138	1,000
	Frame 300	14,285 (6,480)	1,500 (1,120)	191	1,380
	Frame 400	14,285 (6,480)	2,145 (1,600)	262	1,890

3-3.3 kV

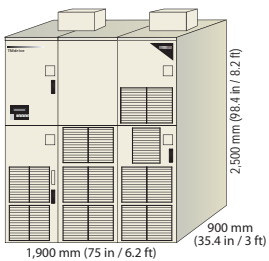
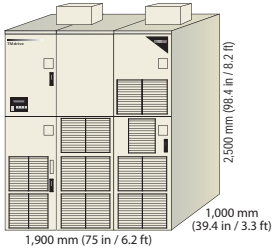
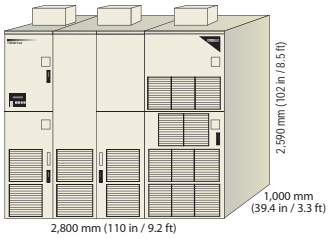
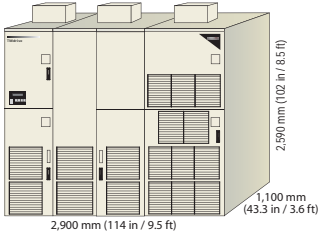
VFD Outline	Maximum Weight lbs. (kg)	Approximate Motor Shaft HP (kW) at 3.3 kV	Rated Output Current (A) I phase AC*	Inverter kVA output at 3.3 kV
	8,400 (3,800)	220 (164)	35	200
		330 (246)	53	300
		440 (328)	70	400
	8,800 (4,000)	660 (492)	105	600
		880 (656)	140	800
	11,700 (5,300)	1,040 (776)	166	950
		1,200 (895)	192	1,100
	12,350 (5,600)	1,400 (1,044)	227	1,300
		1,650 (1,230)	263	1,500

* 1: 110% OL for 60 sec. Panel heights include cooling fans. VFD capable of 80% regeneration at nominal voltage at unity power factor.

[†] Applicable for CSA listed VFD in U.S. and Canada. Frame designation indicates power cell rating for replacement parts and other purposes.

Frame Sizes to Fit Your Application

6-6.6 kV				
VFD Outline	Maximum Weight lbs. (kg)	Approximate Motor Shaft hp (kW) at 6.6 kV	Rated Output Current (A) I phase AC*	Inverter kVA output at 6.6 kV
	Frame 100 8,400 (3,800)	440 (328)	35	400
		660 (490)	53	600
		880 (656)	70	800
	Frame 200 10,360 (4,700)	1,320 (985)	105	1,200
		1,760 (1,312)	140	1,600
	Frame 300 15,000-15,800 (6,750-7,150)	2,085 (1,555)	166	1,900
		2,400 (1,790)	192	2,200
	Frame 400 15,000-15,800 (6,750-7,150)	2,850 (2,126)	227	2,600
		3,300 (2,460)	263	3,000

* 1: 110% OL for 60 sec. Panel heights include cooling fans. VFD capable of 80% regeneration at nominal voltage at unity power factor. Frame designation indicates power cell rating for replacement parts and other purposes.

10-11 kV				
VFD Outline	Maximum Weight lbs. (kg)	Approximate Motor Shaft HP (kW) at 11 kV	Rated Output Current (A) I phase AC*	Inverter kVA output at 11 kV
	Frame 100 16,500 - 17,600 (7,800 - 8,000)	700 (522)	35	660
		1,100 (820)	53	990
		1,400 (1,044)	70	1,320
	Frame 200 16,500 - 17,600 (7,800 - 8,000)	2,200 (1,640)	105	2,000
		2,900 (2,160)	139	2,640
	Frame 300 29,500 - 29,800 (13,350 - 13,500)	3,400 (2,536)	162	3,080
		4,000 (2,984)	191	3,630
	Frame 400 29,500 - 29,800 (13,350 - 13,500)	4,700 (3,500)	226	4,290
		5,500 (4,100)	263	5,000

*1: 110% OL for 60 sec. Panel heights include cooling fans VFD capable of 80% regeneration at nominal voltage at unity power factor. Frame designation indicates power cell rating for replacement parts and other purposes.

Cabinet Minimum Clearance Space

Drive	Frame	Front Side Space	Rear Side Space	Upper Space
3-3.3 kV class	1, 2	1,700 mm (5.6 ft / 67 in)	–	300 mm (1 ft / 11.8 in)
	3, 4	1,700 mm (5.6 ft / 67 in)	–	210 mm (0.68 ft / 8.3 in)
4-4.16 kV class	1, 2, 3, 4	1,700 mm (5.6 ft / 67 in)	–	220 mm (0.72 ft / 8.7 in)
6-6.6 kV class	1, 2	1,700 mm (5.6 ft / 67 in)	–	300 mm (1 ft / 11.8 in)
	3, 4	1,700 mm (5.6 ft / 67 in)	–	210 mm (0.68 ft / 8.3 in)
10-11 kV class	1, 2	1,900 mm (6.2 ft / 75 in)	1,000 mm (3.3 ft / 40 in)	300 mm (1 ft / 11.8 in)
	3, 4	1,900 mm (6.2 ft / 75 in)	1,000 mm (3.3 ft / 40 in)	210 mm (0.68 ft / 8.3 in)

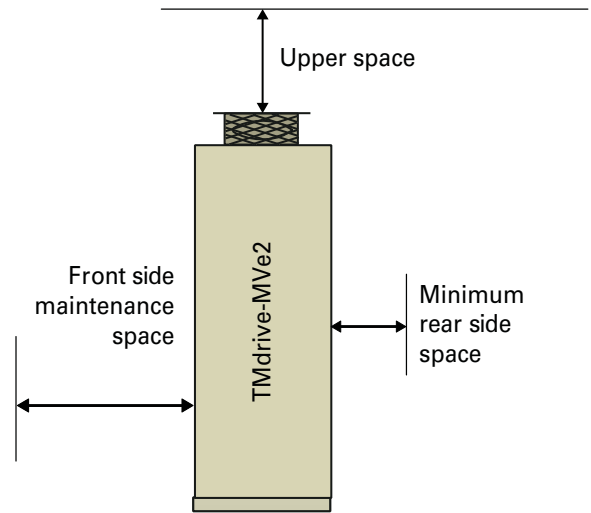

Application Notes

- Inverter Power (kVA) = $\frac{\text{Motor Shaft Power (kW)}}{\text{Motor pf} \times \text{Motor Eff}}$
 Rated Output Current = $\frac{\text{Inverter Power (kVA)}}{1.732 \times \text{Motor Voltage}_{(L-L)}}$
 - Ratings based on motor pf = 0.87, Motor Eff = 0.94, ambient temperature is 32°F–104°F (0°C–40°C)
 - Ratings based on a variable torque load (fans, pumps, centrifugal compressors)
 - For constant to secure load consult TMEIC.
 - Altitude above sea level is 0-3300 ft (1-1000 m).
- Optional bypass circuit can be separately mounted.
- Redundant cooling fans available as an option.
- No rear access required except for 10-11 kV VFDs or 13.8 kV VFDs.
- Incoming power cabling and motor cabling are bottom entry, top entry is standard for CSA design, option for IEC
- Air is pulled through the filters in the cabinet doors and vented out top.
- Available options include motor cooling fan control, cabinet space heater, sync motor control, smooth transfer to and from utility, motor space heater control, RTD, monitor redundant fans, output sine wave filters, and others.
- For conservative sizing of HVAC equipment, use 3kW of heat rejection per 100 hp of motor power.
- The panels include channel bases attached to the cabinets before shipment.
- This table presents only a sample of voltages and horsepower ratings. Other options such as 13.8 kV input are available.

Specifications



VFD Power Input

Mains input voltage	<ul style="list-style-type: none"> Up to 13.8 kV, 3-phase, $\pm 10\%$ Complete power loss ride-thru of 300 ms.
Input frequency	<ul style="list-style-type: none"> 50/60 Hz $\pm 5\%$
Power factor	<ul style="list-style-type: none"> Unity at all loads and speed
Harmonics	<ul style="list-style-type: none"> Lower than IEEE 519-2014 standard No line-side filters required, $< 2\% I_{THD}$
Converter type	<ul style="list-style-type: none"> AC fed active front end
Power semiconductor technology	<ul style="list-style-type: none"> Low loss IGBT
Transformer	<ul style="list-style-type: none"> Dry type, aluminum wound, H-type
Auxiliary power	<ul style="list-style-type: none"> Control power (internal) Fan power: 380V-690V (external)



VFD Power Output

Output Voltage	<ul style="list-style-type: none"> 3/3.3 kV, 4.16 kV, 6/6.6 kV, 10/11 kV
Output Frequency	<ul style="list-style-type: none"> 0-120 Hz for 3/3.3 kV, 4.16 kV, 6/6.6 kV 0-72 Hz for 10/11 kV inverters
Output Voltage Levels	<ul style="list-style-type: none"> 9/17-levels for 3/3.3 kV, 4.16 kV 13/25 levels for 6/6.6 kV 21/41 levels for 10/11 kV
Number of cell modules in series per phase	<ul style="list-style-type: none"> 2 for 3/3.3 kV and 4.16 kV 3 for 6/6.6 kV, 5 for 10/11 kV
Overall Efficiency	<ul style="list-style-type: none"> $> 96.5\%$ Including auxiliaries & isolation transformer
Power Semiconductor Technology	<ul style="list-style-type: none"> Low loss IGBT



Control I/O

Digital Input	Qty. (5)
Dedicated Function Input	Qty. (1)
Configurable (programmable) Function Input	Qty. (4)
Digital Relay Output	Qty. (8)
Digital 24V Outputs	Qty. (4)
Speed feedback encoder input	High resolution tach, 10 kHz, 5 or 15 V DC diff. input, A quad B, with marker
LAN interface options	Profibus-DP, DeviceNet™, or Modbus RTU, TC-Net I/O, CC-link. Others available.
Motor temperature sensor option	High resolution temperature protection relay: 100 Ohm platinum RTD, 14 channels



Display and Diagnostics

PC Configuration	TMdrive-Navigator for configuration, local and remote monitoring, animated block diagrams, dynamic live and capture buffer based trending, fault diagnostics, commissioning wizard, and regulator tune-up wizards. Ethernet 10 Mbps point to point or multi-drop, each drive has its own IP address.
Keypad and Display	Backlit LCD, animated displays <ul style="list-style-type: none"> Four configurable bar graphs Optional multilingual display Parameter editing Drive control
RCM	<i>Remote Connectivity Module</i> Fanless industrial computer in the VFD with proprietary fault upload software for troubleshooting and diagnostics

For specifications not mentioned here, contact TMEIC.



Environmental

Operating Temperature	<ul style="list-style-type: none"> 0° to 40°C (32° to 104°F) at rated load Up to 50°C with derating
Storage Temperature	<ul style="list-style-type: none"> -25° to +70°C, indoor storage only
Relative Humidity	<ul style="list-style-type: none"> Up to 95%, non-condensing
Altitude	<ul style="list-style-type: none"> Up to 1000m (3300 ft) Higher altitude available with derating
Vibration	<ul style="list-style-type: none"> 0.3G max 2Hz<f<9Hz: Half amplitude sine wave is within 0.9m 9Hz<f<100Hz: Vibration acceleration is $< 3m/s^2$
Cooling	<ul style="list-style-type: none"> Air-cooled with fans on top and air intake on front For 10/11kV inverter, air intake in rear also



Mechanical

Enclosure	<ul style="list-style-type: none"> NEMA 1, Gasketed IP 30, except fan opening Color: Munsell 5Y7/1
Cable Entrance	<ul style="list-style-type: none"> Top or bottom Selectable on-site
Noise	<ul style="list-style-type: none"> ~76-80 dBA at 3.1 ft from enclosure
Mean Time To Repair (MTTR)	<ul style="list-style-type: none"> 30 minutes to replace power module
Mean Time Between Failure (MTBF)	<ul style="list-style-type: none"> 16 years
Code conformance	<ul style="list-style-type: none"> Applicable IEC, JIS, JEM, UL, CSA and NEMA standards
Equipment marking	<ul style="list-style-type: none">  4.16 kV variant only



Motor Control and Protection

Vector Control Accuracy	<ul style="list-style-type: none"> Speed response: 20 rad/sec Speed regulation without speed sensor $\pm 0.5\%$ Speed Control Range: 5 - 100%
Control	<ul style="list-style-type: none"> Non-volatile memory for parameters and fault data Vector control with/without speed feedback, or Volts/Hz Designed to keep running after utility supply transient voltage drop outs of 300 ms Synchronous transfer to line (option) Synchronous motor control (option)
Major Protective Functions	<ul style="list-style-type: none"> Inverter overcurrent, overvoltage Cooling fan abnormal Motor ground fault Low or loss of system voltage Over-temperature DC bus voltage Voltage/current unbalance 5/20 min. overload Loss of speed reference Input Voltage phase loss VFD output open Transformer overheat

Empower Your Crew: Local and Remote Control



TMdrive Navigator

The MVe2 keypad, coupled with the Windows® based TMdrive Navigator brings productivity to your commissioning and maintenance activities.



The Navigator tool helps maintain TMEIC drives in the field. Any user can easily access current drive expertise & know-how.

Compatible with OS Windows 7 and Professional 32-bit

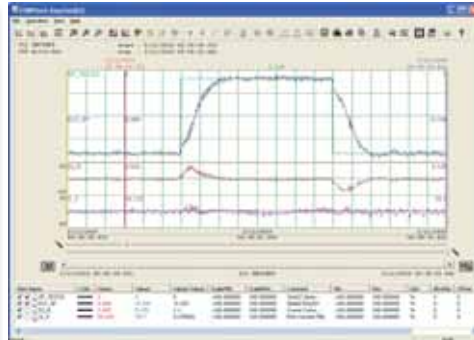

High speed data is automatically captured and saved in the event of a drive fault. Users can capture high speed data based on their own trigger conditions or perform high resolution real-time trending.

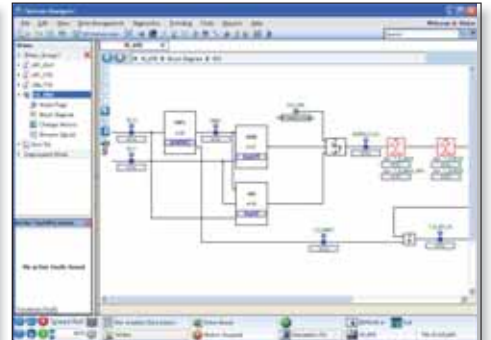

Live block diagrams provide a real-time graphical view of drive functions. Functions can be configured directly from the graphical view.

Product documentation is integrated into tool. Users can capture their own notes to benefit future troubleshooting.



Operator Keypad (Standard)

High Function Display

- LCD backlight gives great visibility & long life
- Bar graphs, icons, menus, and digital values combine to provide concise status information, often eliminating the need for traditional analog meters

RJ-45 Ethernet port is used for the TMdrive Navigator



Easy to understand navigation buttons allow quick access to information without resorting to a PC based tool

Switch to local mode to operate the equipment from the keypad

Instrumentation Interface

- Two analog outputs are dedicated to motor current feedback
- Five analog outputs are mapped to variables for external data logging and analysis

Interlock button disables the drive



Multilingual Keypad (Optional)

An optional touch screen display is available with 9 languages built in. The graphic display is easy to read and understand and contains all of the same functions as the standard keypad.



Remote Connectivity **RCM[®]**

At TMEIC, we provide highly reliable automation systems, additionally TMEIC offers remote connectivity with RCM[®].

Protection for your investment, by reducing downtime and lowering repair costs.

Remote drive connectivity requires an internet connection between your facility and TMEIC for retrieval of fault logs and files for diagnosing drive upsets. The RCM[®] enables seamless integration between drives and support engineers.

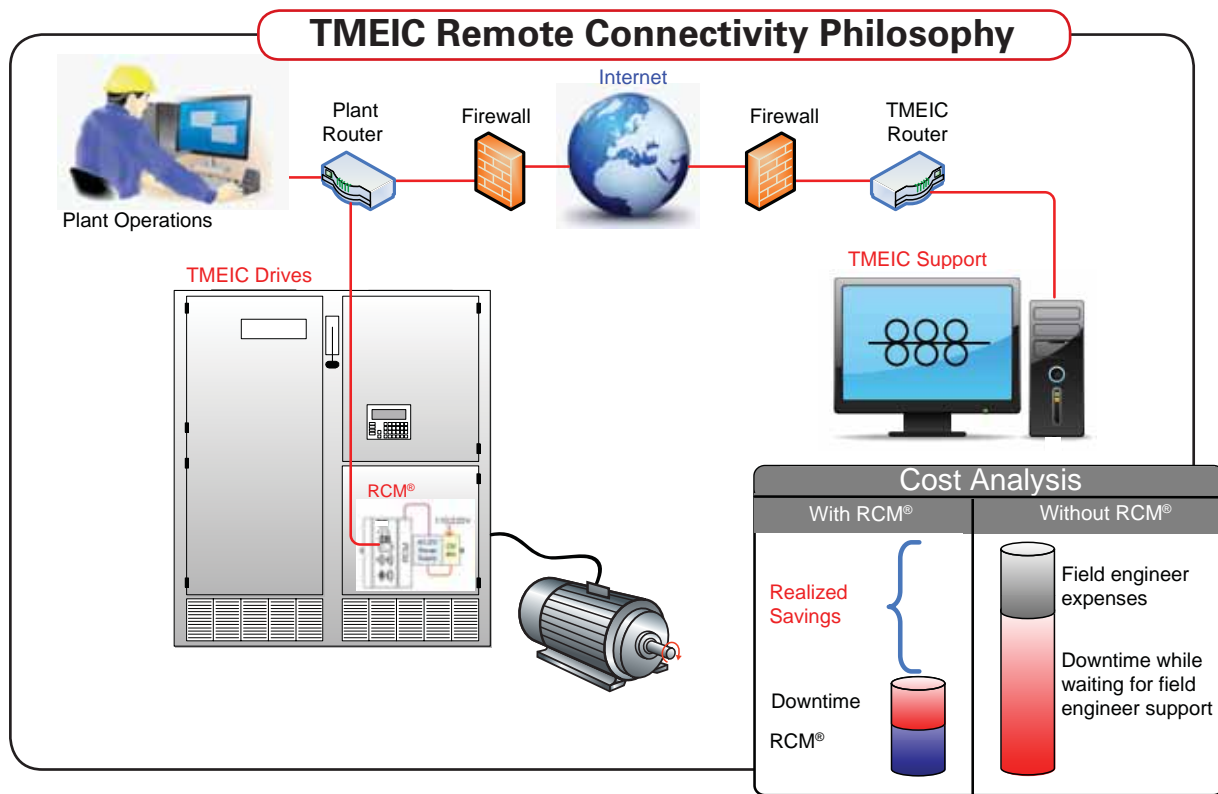

Features

- **Reduced downtime & mean-time-to-repair**
- **Secured connection**
- **Fault upload utility**
- **Industrial computer**
- **Multiple ethernet/serial ports**

Benefits

Quick support saves thousands in lost production

TMEIC engineers can quickly connect to the drive and diagnose many issues in minutes.

Customer-controlled access

All remote activity is conducted with permission of the customer. Drive start/stop is not permitted remotely.

Proprietary fault upload software

RCM[®] can monitor key real-time parameters. Historical drive faults are pushed automatically to the computer. This enables TMEIC engineers to analyze the issue resulting in the fault and provide a more coherent solution.

Rugged computer for the most demanding applications

Fanless computer withstands high vibration and temperature ranges in a small DIN-rail mounted footprint

Flexible connectivity

The module can be connected to two separate LANs along with a host of serial talking USB devices.

Customer Service

North American Sales and Service Network

Whether the equipment is up and running or experiencing downtime, live help from TMEiC is a phone call away. With bases in North America and around the world, regional TMEiC companies and TMEiC motor service shops provide reliable support whenever needed.

- 77 TMEiC VFD Service Engineers
- 43 Motor service locations
- Authorized VFD service providers
- Authorized MV Motor Repair Technicians

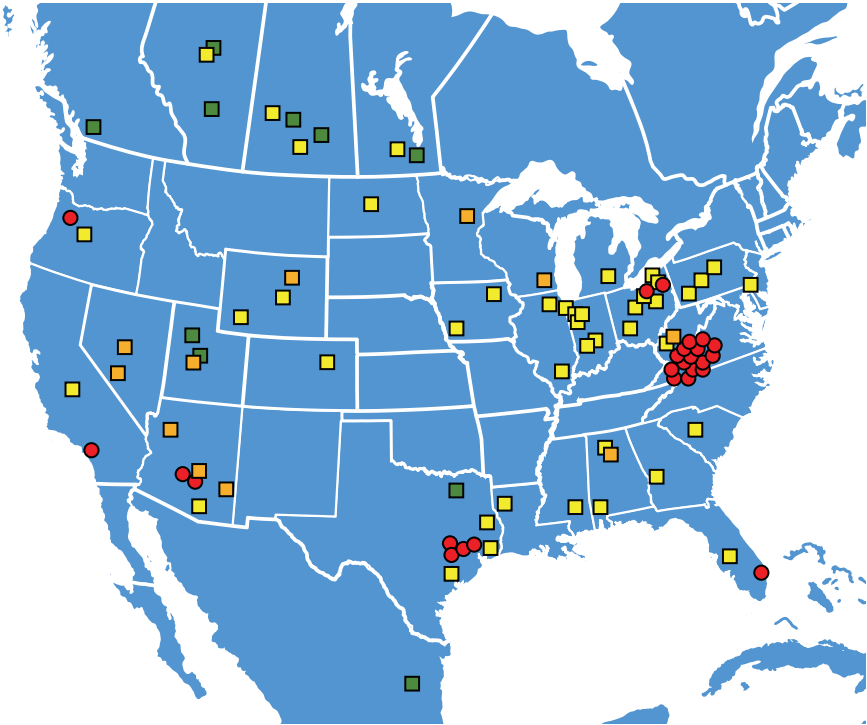

TMEiC
For Service or Parts, call
1-877-280-1835
INTERNATIONAL:
+1-540-283-2010
24 Hours / 7 days

Service 24/7 – Talk to a service engineer, we’re available when you need us

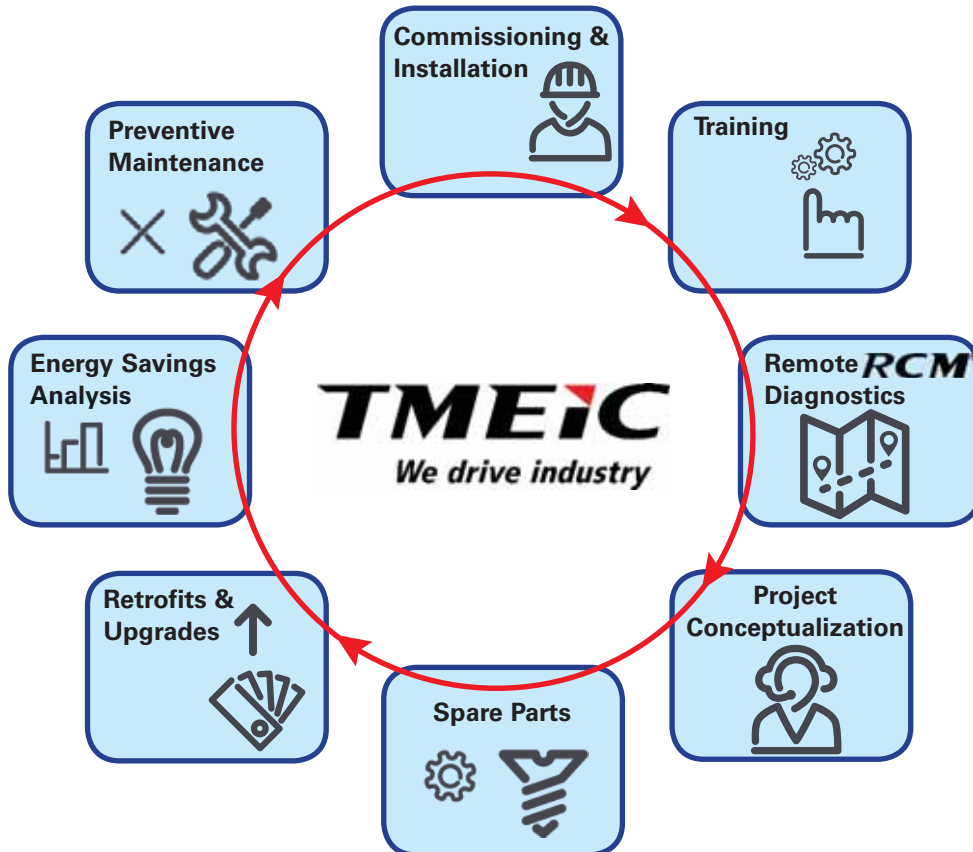

Quote Contact Information

Customer Reference: _____ Quote Due Date: _____
 Project Name: _____ Equipment Delivery Date: _____
 Contact Name: _____ # of Units Required: _____
 Contact Number: _____ TMEiC Representative: _____
 *Please complete one request for each unique motor rating

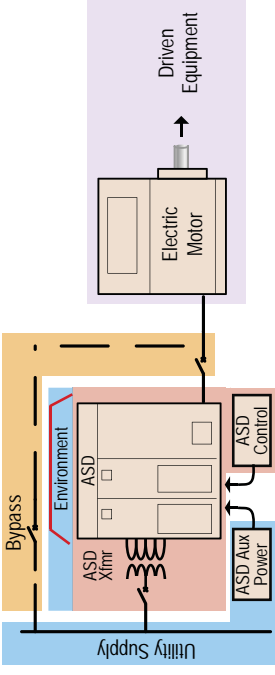

Driven Equipment & Motor Details

*Type of load: Fan Pump Compressor
 Other (specify): _____
 Torque profile: Variable Constant
 Other (specify): _____
 Gear box ratio: _____ to _____ None
 Speed range: _____ Hz to _____ Hz
 Load torque/speed curve provided: Yes No
 Ref: _____
 Regeneration: Yes No
 Breakaway torque:
 0% - 100% 101% - 150% >150%
 % Overload Rating for 1 minute: _____
 *Motor power (HP): _____
 *Motor voltage (V): _____
 *Motor full load (A): _____
 *Motor Speed (RPM): _____
 New Motor Existing Motor
 Service factor: _____
 Motor space heater (Control): By ASD By Others
 Motor RTD: Qty. _____ Type _____ To ASD
 To others (specify): _____
 Encoder: Yes No
 Cable distance from motor to ASD: _____ ft
 Inverter duty motor: Yes No
 Motor rated to start direct-on-line: Yes No

Note:
 *Required fields for budgetary quotation.

Download more copies
 (<http://tinyurl.com/ASDchecklistTMEiC>)

Utility Supply & Environment

*System Voltage:
 2400V 3300V 4160V 6900V
 13800V Other: _____ V ± _____ %
 Power System One-line Diagram Provided: Yes No
 Ref: _____
 *Line frequency: 60 Hz 50 Hz
 ASD auxiliary three-phase power:
 End user supplied or Internal to ASD
 Control power:
 End user supplied or Internal to ASD
 UPS: Yes No; By TMEiC By others
 *Site location: _____
 Elevation: _____ meters above sea level
 ASD enclosure NEMA 1 or NEMA 3R
 Electrical room provided by: TMEiC Others
 Elec. room max. ambient: _____ °C
 Humidity: _____ % (non-cond.)
 Elec. room min. ambient: _____ °C
 Humidity: _____ % (non-cond.)
 Outdoor contamination (eg: corrosive gases): _____
 ASD cabinet space heater? Yes No

ASD Design/Requirements Performance

ASD Design Standards

- UL347A or IEC61800-5-1
- Other/National/Local: _____

ASD Cooling Method

- Air-cooled Water cooled

Site cooling water for ASD use: Yes No

***Input ASD Switchgear**

- TMEiC or Others

If other, provide detail: _____

Cable entry: Top Bottom

*ASD Duty Cycle Continuous duty Starting only

Bypass operation

- Direct-on-line starter
- Solid state starter
- Synchronous transfer by ASD
- Synchronous transfer by ASD

Number of motors _____

Bypass gear By TMEiC By Others

If others, provide gear details: _____

Testing

- ASD standard client witness test
- ASD witness client test with dynamometer
- ASD/Motor combined test at external test facility

Other tests _____

Motor Protection

(Not necessary for continuous ASD operation)

- 6 channel RTD RELAY
- MULTILIN 369
- MULTILIN 469

Spares

Spare parts kit: Yes No

Spare Power Module: Yes No

ASD Controls and Indications

Control Strategy

- Volts/Hz speed control Master-follower
- Sensorless vector 0.5% without tachometer
- Closed loop vector control 0.01% with tachometer
- Other _____

Communication Options

- EGD DEVICENET
- PROFIBUS ACU Cond.
- MODBUS RTU/PLUS OTHER _____

Indications

- ASD fault indication Local/remote selector switch
- ASD alarm indication ASD run indication
- Start ASD ready indication
- Emergency stop button Stop push button
- Fault clear button Other _____

Options

Kirk key interlocks: Yes No

4-20mA Isolated Analog Outputs Yes No

Speed Current Voltage

Load Other _____

Redundant fan Yes No

Additional controls Yes No (attach control schematic)

Additional notes _____

Get Quote from TMEiC



Customer Success. Every Project, Every Time.

Note: All TMEiC ASDs are manufactured with standard digital I/Os, Analog I/Os, push buttons, and indications as specified in the Application Guide.



TMEIC AC Drives Offer Complete Coverage

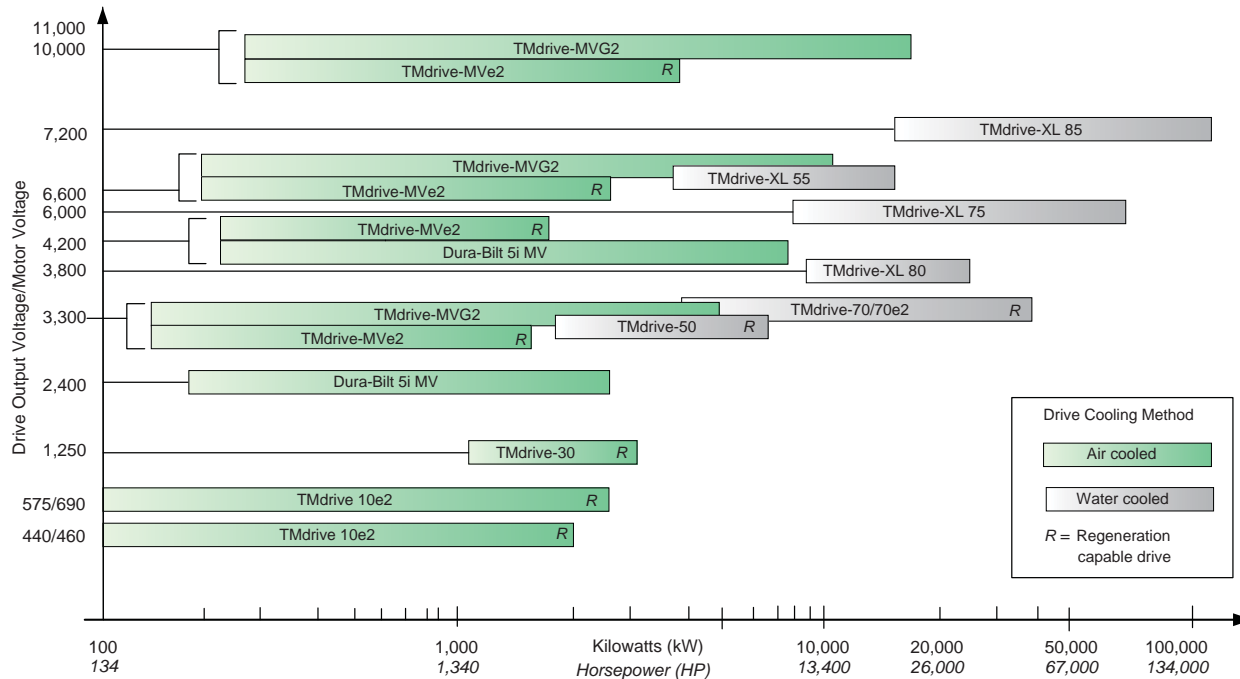

Global Office Locations:

TMEIC Corporation

Office: 1325 Electric Rd., Roanoke, VA, 24018, U.S.A.
 Mailing: 2060 Cook Drive, Salem, VA, 24153, U.S.A.
 Tel.: +1-540-283-2000; Fax: +1-540-283-2001
 Email: info@tmeic.com; Web: www.tmeic.com

Houston Branch: Houston, TX;

Tel: +1-832-767-2680; Email: OilGas@tmeic.com

TMEIC Power Electronics Products Corporation

Factory: 6102 North Eldridge Parkway, Houston, TX 77041
 Mailing: 13131 W. Little York Road, Houston, TX 77041

TMEIC-Sistemas Industriais da América do Sul Ltda.

São Paulo/SP, Brazil
 Tel: +55-11-3266-6161; Fax: +55-11-3253-0697

Toshiba Mitsubishi-Electric Industrial Systems Corp.

Tokyo, Japan; Tel: +81-3-3277-5511; Web: www.tmeic.co.jp

TMEIC Europe Limited

Uxbridge, Middlesex, United Kingdom
 Tel.: +44 870 950 7220; Fax: +44 870 950 7221
 Email: info@tmeic.eu; Web: www.tmeic.com/europe

TMEIC Industrial Systems India Private Limited

Hyderabad, India;
 Tel.: +91-40-4434-0000; Fax: +91-40-4434-0034
 Web: www.tmeic.in; Email: inquiry_india@tmeic.in
 Mumbai Branch: Mumbai, Maharashtra, India
 Tel: +91-22-6155-5444; Fax: +91-22-6155-5400

TMEIC Power Electronics Systems India Private Ltd.

Bangalore, India,
 Tel: +91-80-6746-6000; Fax: +91-80-6746-6100

Toshiba Mitsubishi-Electric Industrial Systems (China) Corp.

Beijing China; Tel.: +86 10 5873-2277; Fax: +86 10 5873-2208
 Email: sales@tmeic-cn.com
 Shanghai Branch: Shanghai Works

Tel: +86-21-69925007; Fax: +86-21-69925065

Yangcheng TMEIC Power Electronics Corporation

Yangcheng, Jiangxi, China

Shanghai Bao-ling Electric Control Equipment Co., Ltd.

Shanghai, China; Tel: +86-21-5660-3659; Fax: +86-21-5678-6668

Guangzhou Toshiba Baiyun Ryoki Power Electronics Co., Ltd.

Guangzhou, China; Tel: +86-20-2626-1625 Fax: +86-20-2626-1290

TMEIC Asia Company Limited

Hong Kong, China; Tel: +852-2243-3221; Fax: +852-2795-2250
 Singapore Branch: Tel: +65-6292-7226 FAX: +65-6292-0817
 Taiwan Office: Tel: +886-7-2239425 Fax: +886-7-2239122

P.T. TMEIC Asia Indonesia

Jakarta; Tel: +62-21-2966-1699; Fax: +62-21-2966-1689

TMdrive is a registered trademark of TOSHIBA MITSUBISHI-ELECTRIC INDUSTRIAL SYSTEMS CORPORATION.

All other products mentioned are registered trademarks and/or trademarks of the respective companies.

All specifications in this document are subject to change without notice. This brochure is provided free of charge and without obligation to the reader or to TMEIC Corporation, and is for informal purposes only. TMEIC Corporation does not accept, nor imply, the acceptance of any liability with regard to the use of the information provided. TMEIC Corporation provides the information included herein as is and without warranty of any kind, express or implied, including but not limited to any implied statutory warranty of merchantability or fitness for particular purposes. The brochure is not an implied or express contract.

If you have questions regarding your project requirements, please contact TMEIC Corporation at 540-283-2000.